

# EA637 GL・GM・GN 六角ナット 焼入れ鋼

フランジ

フラット

エキステンション



GL





GM



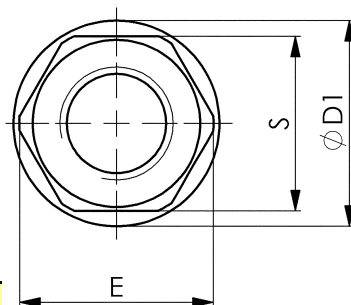
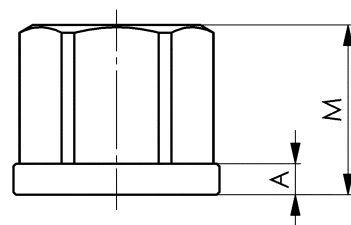

GN

品番	Size	A	D1	E	M	S	 [g]
EA637GL-6	M6	3.0	14	11.05	9	10	6
EA637GL-8	M8	3.5	18	14.40	12	13	12
EA637GL-10	M10	4.0	22	17.80	15	16	21
EA637GL-12	M12	4.0	25	20.03	18	18	30
EA637GL-14	(M14)	4.5	28	23.40	21	21	43
EA637GL-16	M16	5.0	31	26.80	24	24	70
EA637GL-18	(M18)	5.0	34	30.10	27	27	95
EA637GL-20	M20	6.0	37	33.50	30	30	130
EA637GL-22	(M22)	6.0	40	37.70	33	34	200
EA637GL-24	M24	6.0	45	40.00	36	36	230
EA637GL-27	M27	8.0	50	45.60	40	41	320
EA637GL-30	M30	8.0	58	51.30	45	46	470
EA637GL-36	M36	10.0	68	61.30	54	55	800
EA637GL-42	M42	12.0	80	72.60	63	65	1340
EA637GL-48	M48	14.0	92	83.90	72	75	2040

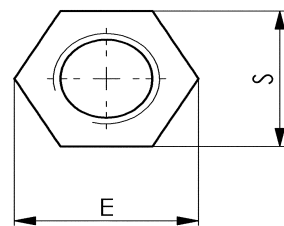
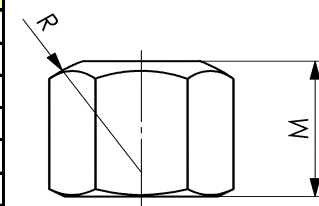

品番	Size	E	M	R	S	 [g]
EA637GM-6	M6	11.05	9	9	10	5
EA637GM-8	M8	14.40	12	12	13	9
EA637GM-10	M10	17.80	15	15	16	14
EA637GM-12	M12	20.03	18	17	18	20
EA637GM-14	(M14)	23.40	21	20	21	34
EA637GM-16	M16	26.80	24	22	24	58
EA637GM-18	(M18)	30.10	27	24	27	83
EA637GM-20	M20	33.50	30	27	30	110
EA637GM-22	(M22)	37.70	33	30	34	185
EA637GM-24	M24	40.00	36	32	36	195
EA637GM-27	(M27)	45.60	40	36	41	280
EA637GM-30	M30	51.30	45	41	46	405
EA637GM-36	M36	61.30	54	50	55	715
EA637GM-42	M42	72.60	63	58	65	1170
EA637GM-48	M48	83.90	72	67	75	1800



品番	Size	E	M	S	 [g]
EA637GN-6	M6	11.05	18	10	8
EA637GN-8	M8	14.40	24	13	19
EA637GN-10	M10	17.80	30	16	30
EA637GN-12	M12	20.03	36	18	48
EA637GN-14	M14	23.40	42	21	73
EA637GN-16	M16	26.80	48	24	120
EA637GN-18	M18	30.10	54	27	170
EA637GN-20	M20	33.50	60	30	240
EA637GN-22	M22	37.70	66	34	390
EA637GN-24	M24	40.00	72	36	400
EA637GN-27	M27	45.60	81	41	600
EA637GN-30	M30	51.30	90	46	850
EA637GN-36	M36	61.30	108	55	1470
EA637GN-42	M42	72.60	126	65	2340
EA637GN-48	M48	83.90	144	75	3600

